

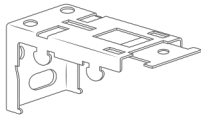

ROMAN BLINDS
FITTING INSTRUCTIONS
SHADE IN STYLE
BESPOKE WINDOW DRESSINGS

YOU SHOULD HAVE



Fixing brackets:
quantity to suit
length of blind



P-Clip

TOOLS REQUIRED

Screw driver



Drill



Tape measure

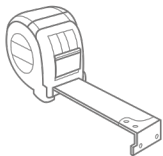

Pencil



THE INSTALLATION OF
THIS PRODUCT SHOULD BE
CONDUCTED BY SOMEONE
COMPETENT IN DIY.

STEP 1

BRACKET POSITION

Place blind in fitting position, space the brackets evenly.

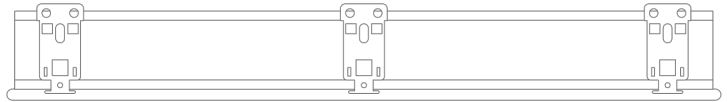

STEP 2

INSTALLING BRACKETS

Face Fixing

Position bracket against the surface and
mark out the holes in the back of the
bracket. Use rawl plugs if fitting to the wall.

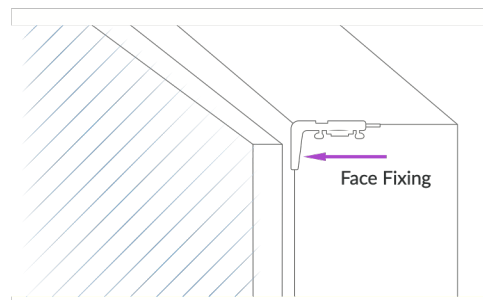

Top Fixing

Position bracket against the surface and
mark out the holes in the top of the bracket.
Use rawl plugs if fitting to the wall.

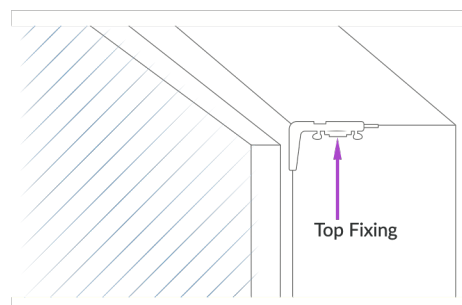

STEP 3

FITTING THE HEADRAIL

Place the front lip of the headrail into the first cradle on the bracket. Gently push back against the cradle and it will withdraw, allowing you to hook the back lip of the headrail into the back cradle. Simply release the headrail and your blind will be locked in place.

The headrail shall not be installed at less than 1.5 m from the floor.

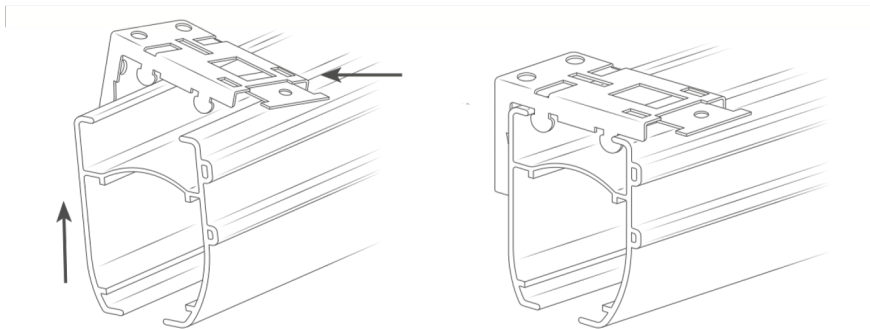

STEP 4

OPERATING YOUR BLIND

* Once installed, use the operating chain at the side to raise and lower your blind.

P-CLIP

The device must be installed at maximum distance possible from the control mechanism, and not less than 1.5m from the floor, to prevent the looped cord/chain from becoming slack.

1. Ensure the control chain is inside the P-Clip.
2. Ensure the chain is taut and that the P-Clip is at the bottom of the loop and that the chain's able to manoeuvre properly.
3. Screw the P-Clip to a wall adjacent to the blind ensuring that the chain remains taut. The chain will be held permanently taut and under constant tension.



CORD SAFETY

The cords on the back are connected to breakaway clips which disconnect when weight is put on the cords.

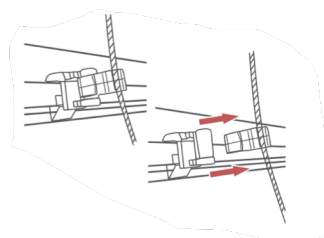

PLEASE READ THE INSTRUCTIONS BEFORE OPERATING THIS PRODUCT

MAINTENANCE

The product is maintenance free however we recommend that regular visual checks are completed to ensure that no components have been damaged, which could result in operating difficulties and/or cause a safety risk.

If any maintenance is required we recommend that the work is carried out immediately, by a reputable blind company.



**make it
safe**TM

BBSA[®]
BRITISH BLIND & SHUTTER ASSOCIATION

WARNING

Young children can be strangled by loops in pull cords, chains, tapes and inner cords that operate the product.

To avoid strangulation and entanglement, keep cords out of the reach of young children. Cords may become wrapped around a child's neck. Move beds, cots and furniture away from window covering cords.

Do not tie cords together. Make sure cords do not twist and create a loop.

