

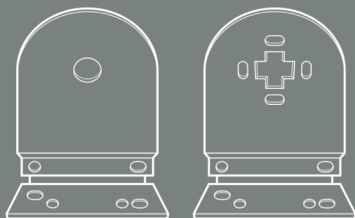

ROLLER BLINDS
FITTING INSTRUCTIONS

SHADE IN STYLE
BESPOKE WINDOW COVERING

YOU SHOULD HAVE



BRACKETS

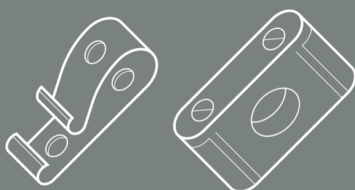

SAFETY DEVICES

- 2 - Piece Cleat
- Cord & Chain Tidy

TOOLS REQUIRED

- Screwdriver
- Pencil
- Power-Drill
- Tape Measure

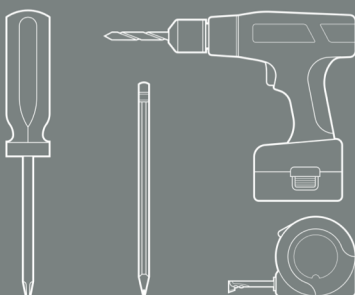

STEP 1

THE INSTALLATION OF THIS PRODUCT SHOULD BE CONDUCTED BY SOMEONE COMPETENT IN DIY.

OUTSIDE RECESS

If the blind is to be fitted outside the window ensure that measurement C is the same. Follow instructions for FACE FIXING. To calculate C $(A-B)/2$.

INSIDE RECESS

TOP FIX to the lintel. FACE FIX bracket to the window frame.

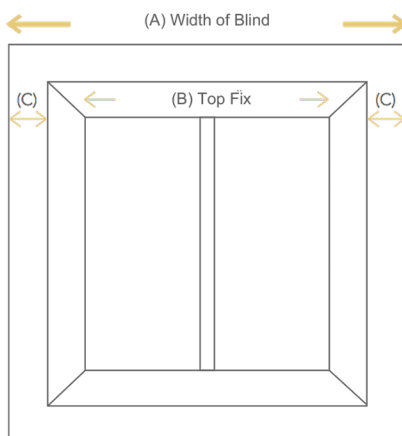

STEP 2

TOP FIXING

Measure and mark the distance (D), allowing for obstructions like handles that protrude into the recess area. Hold each bracket into place and mark the hole positions. Fit each bracket using suitable screws. Please ensure fixings are suitable for the wall/surface to which you are mounting the brackets.

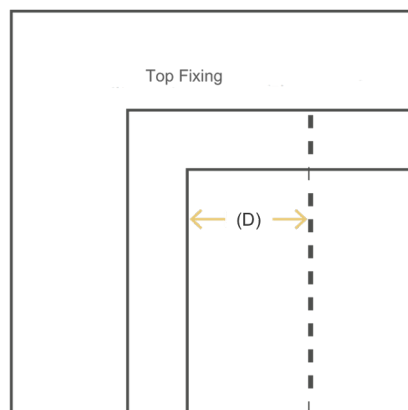

FACE FIXING

Hold each bracket into place and mark the hole positions. Fit each bracket using suitable screws. Please ensure fixings are suitable for the wall/surface to which you are mounting the brackets.

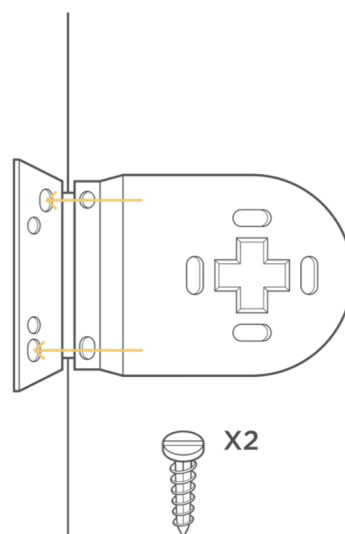

CHILDREN CAN STRANGLE IF A SAFETY DEVICE IS NOT INSTALLED. ALWAYS USE A SAFETY DEVICE TO KEEP CORDS AND CHAINS OUT OF REACH OF CHILDREN.

STEP 3

Holding the fully-wound blind, insert the idle pin end into the bracket as shown.

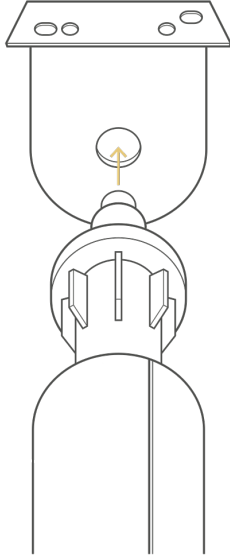

With the Idle pin end in place. Insert the control end into the opposite bracket by depressing the pin end then pull down vertically until the control end clicks into position.

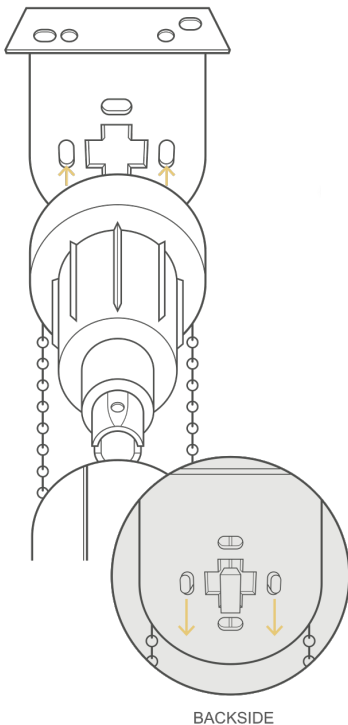

STEP 4

SAFETY DEVICE

The safety device must be installed at the maximum distance possible from the control mechanism to prevent looped chain becoming slack. Place the safety device on the wall and mark the positioning of the 2 screw holes. Drill holes using a suitable drill bit. Place device into position ensuring the chain is fully taut.

(If your blind is supplied with a child safe easy break chain connector, there is no requirement to fit an additional child safety device- steps 4 and 5 can be skipped)

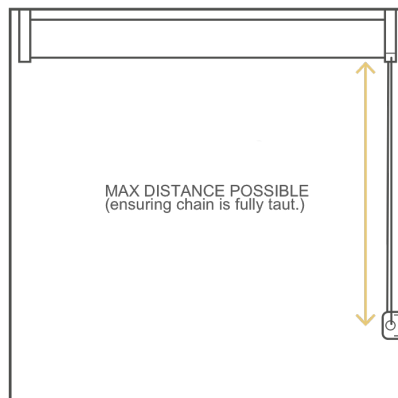

STEP 5

FITTING THE SAFETY DEVICE

Screw the safety device securely to the wall using suitable fixings. (an additional child safety device- steps 4 and 5 can be skipped)

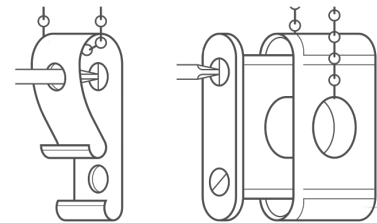

2 - Piece Cleat

Cord & chain tidy

FABRIC RUN-OFF

Diagram 1 below shows the fabric running off from the right-hand side of the blind. To correct the run-off, unroll the fabric, place a 25mm piece of sticky tape onto the tube (Diagram 2) at the opposite end of the blind to the run-off. Fully wind the blind up. Repeat until the fabric is no longer running-off.

Diagram 1

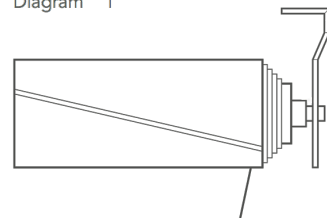
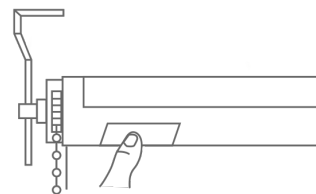

Diagram 2



PLEASE READ THE INSTRUCTIONS BEFORE OPERATING THIS PRODUCT

STANDARD ROLL

(Fabric unrolls from behind blind)

1. To lower the fabric on the roller blind gently pull the operating chain closest to the window.
2. To raise the fabric on the blind gently pull the operating chain furthest from the window.
3. Where possible operating chain should be operated from just above the chain connector as this puts less pressure on this component, reducing the risk of snapping or pulling apart.

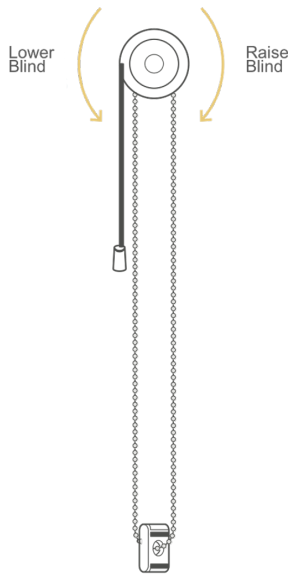

REVERSE ROLL

(Fabric unrolls from front of blind)

1. To lower the fabric on the roller blind gently pull the operating chain furthest from the window.
2. To raise the fabric on the roller blind gently pull the operating chain closest to the window.
3. Where possible operating chain should be operated from just above the chain connector as this puts less pressure on this component, reducing the risk of snapping or pulling apart.

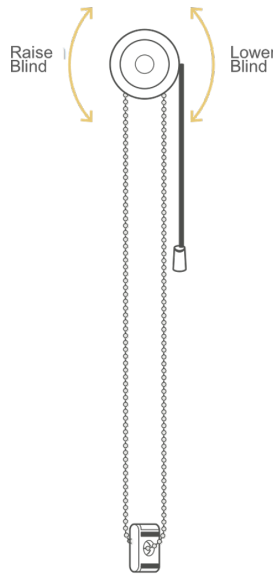

MAINTENANCE

The product is maintenance free however we recommend that regular visual checks are completed to ensure that no components have been damaged, which could result in operating difficulties and/or cause a safety risk.

If any maintenance is required we recommend that the work is carried out immediately, by a reputable blind company.



make it safeTM

BBSA[®]
BRITISH BLIND & SHUTTER ASSOCIATION

WARNING

Young children can be strangled by loops in pull cords, chains, tapes and inner cords that operate the product. To avoid strangulation and entanglement, keep cords out of the reach of young children.

Cords may become wrapped around a child's neck. Move beds, cots and furniture away from window covering cords. Do not tie cords together. Make sure cords do not twist and create a loop.

